

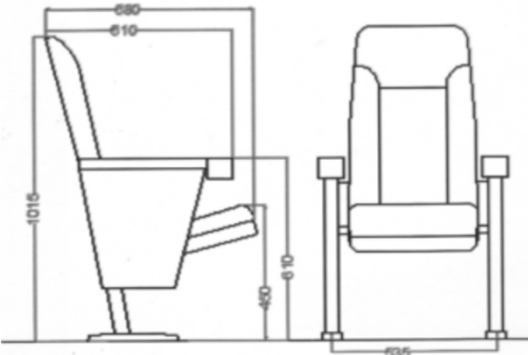





Auditorium & Cinema Chairs

Ref.No.: PR/SF/1112016-3

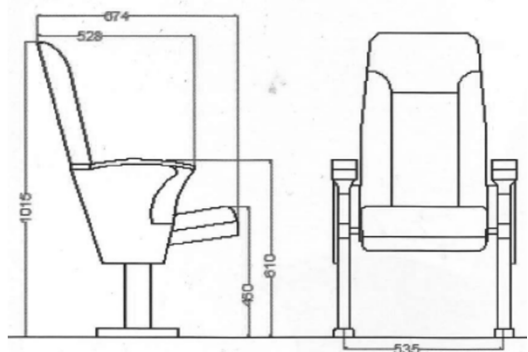
Model Number	Product Picture	Drawing	Material Specification	Option Available	
				Fix Chair	Pushback
PR-FF-01			<p>Made Up Of Moulded PU Foam Of 45 ±5 Density Tubular Steel Structure For Stand Metal Frame For Seat & Back Frame PPCP Plastic Tray For Seat & Back Cover PPCP Arm Rest With Cup Holder Laminated Fabric</p> <p>Color : Standard Colors Avialable for Fabric</p>	<input checked="" type="checkbox"/>	<input checked="" type="checkbox"/>
PR-FF-02			<p>Moulded Polyurethane Foam Of Density 45±5 Density Tubular Steel Structure Stand Metal Frame For Seat & Back Frame PPCP Tray For Seat & Back Cover Skinned Integral Armrest Without Cup Holder Laminated Fabric</p> <p>Color : Standard Colors Avialable for Fabric</p>	<input checked="" type="checkbox"/>	<input checked="" type="checkbox"/>

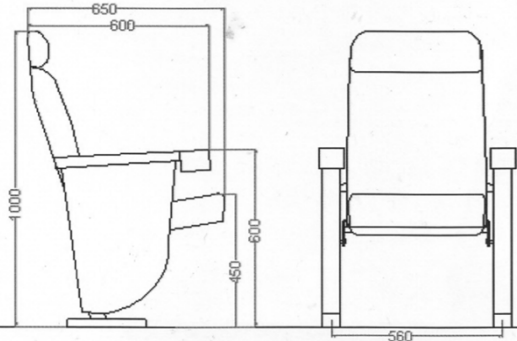

Auditorium & Cinema Chairs

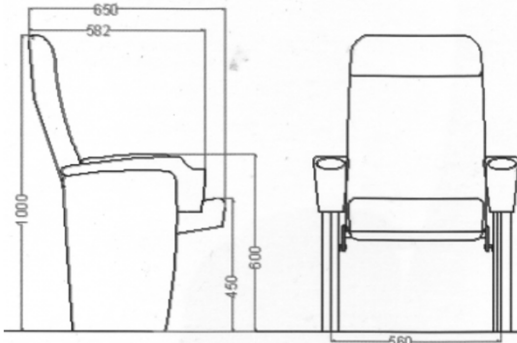
Ref.No.: PR/SF/1112016-3

Model Number	Product Picture	Drawing	Material Specification	Option Available	
				Fix Chair	Pushback
PR-FF-03			<p>Pushback Chair , Auto Tip from 22 inch ctc to 23 inch ctc.</p> <p>Made Up Of Moulded PU Foam Of 45 ±5 Density Tubular Steel Structure For Stand Metal Frame For Seat & Back Frame PPCP Plastic Tray For Seat & Back Cover ABS Plastic Tray For Seat & Back Cover Laminated Fabric</p> <p>Color : Standard Colors Avialable for Fabric</p>	<input type="checkbox"/>	<input checked="" type="checkbox"/>
PR-FF-04			<p>Pushback Chair , Auto Tip from 22 inch ctc to 23 inch ctc.</p> <p>Available in Size 22 Inch CTC to 23 Inch CTC. Raw Plate Indicator on the Aisle Side Chair. Side Light Assembly Arrangement on the Aisle Side Chair for Pathway.</p> <p>Color : Standard Colors Avialable for Fabric</p>	<input type="checkbox"/>	<input checked="" type="checkbox"/>

Auditorium & Cinema Chairs

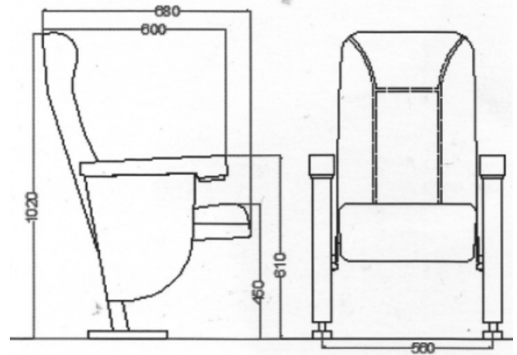
Ref.No.: PR/SF/1112016-3

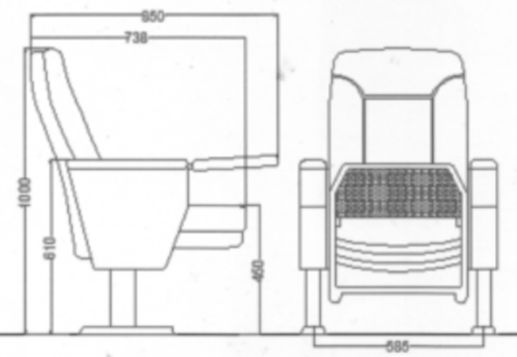
Model Number	Product Picture	Drawing	Material Specification	Option Available	
				Fix Chair	Pushback
PR-FF-05			<p>Fixed Chair , Auto Tip from 22 inch ctc to 23 inch ctc.</p> <p>Pushback Chair , Auto Tip from 22 inch ctc to 23 inch ctc.</p> <p>ABS Forming tray for Seat & Back Cover with Different Color Shade.</p> <p>Fabric Upholster Armrest with PPCP Cup Holder.</p> <p>Row Plate Indicator on the Aisle Side Chair.</p> <p>Side Light Assembly Arrangement on the Aisle Side Chair for Parthway.</p>	<input checked="" type="checkbox"/>	<input checked="" type="checkbox"/>
PR-FF-06			<p>Fixed Chair , Auto Tip from 22 inch ctc to 23 inch ctc.</p> <p>ABS Forming tray for Seat & Back Cover with Different Color Shade.</p> <p>Row Plate Indicator on the Aisle Side Chair.</p> <p>Writing Tablet is avialable in Wooden & Plastic</p> <p>Side Light Assembly Arrangement on the Aisle Side Chair for Parthway.</p>	<input checked="" type="checkbox"/>	<input type="checkbox"/>

Auditorium & Cinema Chairs

Ref.No.: PR/SF/1112016-3

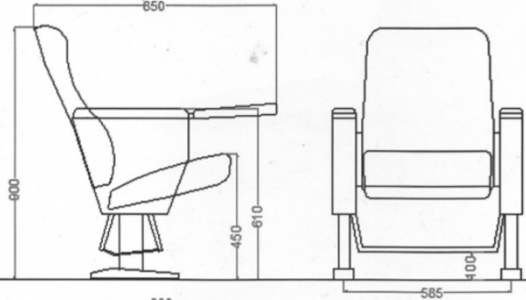
Model Number	Product Picture	Drawing	Material Specification	Option Available	
				Fix Chair	Pushback
PR-FF-07			<p>Made Up Of Moulded PU Foam, With Density 45 + / - 5 Density.</p> <p>Tubular Steel Structure For Stand.</p> <p>Wooden Compressed Frame For Seat & Back Frame.</p> <p>Full Fabric Upholster Cover For Seat & Back.</p> <p>Skinned Integral Arm Rest Without Cup Holder.</p> <p>Furnishing Fabric.</p> <p>Available In Fixed Type Only.</p> <p>Available In Non Auto Tip.</p> <p>Row Plate Indicator On The Aisle Side Chair.</p> <p>Side Light Assembly Arrangement On The Aisle Side Chair For Pathway.</p> <p>Baggage Rack Below The Chair.</p>	<input checked="" type="checkbox"/>	<input type="checkbox"/>